

NC7CX High-performance counter

DIN 48×48mm, 6 digits counter

- Bright, easy to read color LCD display, showing a new standard in the future!
- Each digit has a corresponding button, simple operation and fast, the key-protect switch to prevent misuse.
- Terminals with protective cover to prevent electric shock.
- Powerful features, choice of models to meet different occasions.
- Enhanced anti-jamming design, count accurate and reliable.
- NPN / PNP input signal can be switched.



One-shot output time	0.01 to 99.99 s
Control output	Contact output: 3 A at 250 VAC/30 VDC, resistive load (cosφ=1) Minimum applied load: 10 mA at 5 VDC (failure level: P, reference value) Transistor output: NPN open collector, 100 mA at 30 VDC Residual voltage: 1.5 VDC max. (approx. 1 V)
External power supply	12 VDC (± 10%), 100 mA Max
Sensor waiting time	250 ms max. (Control output is turned OFF and no input is accepted during sensor waiting time.)
Memory backup	EEPROM (overwrites: 100,000 times min.) that can store data for 10 years min.
Ambient	Operating temperature: -10 to 55°C (-10 to 50°C if counters are mounted side by side) (with no icing or condensation) Storage temperature: -25 to 65°C (with no icing or condensation) Ambient humidity: 25% to 85%

Please refer to the manual, to ensure the safe and proper use of the product

■ Ratings

Model	NC7CX-C	NC7CX-CP	NC7CX-CSP	NC7CX-CWP	NC7CX-CTP	NC7CX-CAP	NC7CX-CBP	NC7CX-CDP
Category	1-stage counter (Basic model)	1-stage counter (Prescaling function)	1-stage counter (Input amendment)	2-stage counter	total counter (Can preset total value)	total counter (Total value can not be preset)	Batch counter	Dual counter
Input modes	UP, DOWN, UP/DOWN-A, UP/DOWN-B, UP/DOWN-C			UP	UP	UP, DOWN, UP/DOWN-A, UP/DOWN-B, UP/DOWN-C		ADD
Output modes	N, F, C, R, L		N, F, C, R, L, K, D	N, F, C, R, L, K, D, H	N, F, C, R	N, F, C, R, L, K, D		
Prescaling function	NO	Yes (0.001 to 99.999)						
Decimal point	NO	Yes (rightmost 3 digits)						
voltage	1: AC100~240V 50/60HZ 2: AC/DC12~24V (Allowable voltage range: 85 ~ 110%)							
Power consumption	Approx. 5VA (AC240V), Approx. 3.2VA (DC24V)							
Display	7-segment, negative transmissive LCD Display range: -99999~999999							
counting speed	5Hz、30Hz、1KHz、5KHz (selectable, ON/OFF ratio 1:1)							
Input signals	CP1, CP2, reset, and total reset							
Input method	No-voltage input/voltage input (switchable) No-voltage input ON impedance: 1 kΩ max. (Leakage current: 5 to 20 mA at 0 Ω), ON residual voltage: 3 V max. OFF impedance: 100 kΩ min. Voltage input High (logic) level: 4.5 to 30 VDC, Low (logic) level: 0 to 2 VDC (Input resistance: approx. 4.7 kΩ)							
Reset input	Minimum reset input signal width: 20 ms							
Reset system	External, manual, and automatic reset (internal according to C, R, and K mode operation)							
Gross weight	Approx. 179 g		Approx. 189 g		Approx. 179 g	Approx. 189 g	Approx. 179 g	

■ Panel

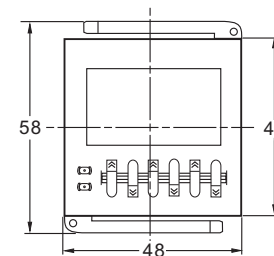
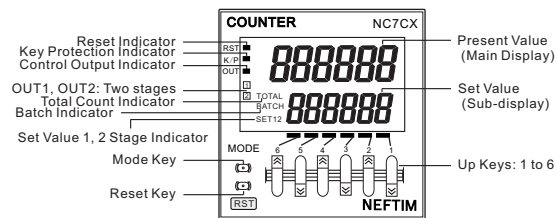

■ Size(mm)

● Outline dimensions

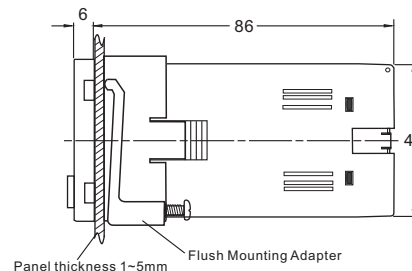

● Panel Cutout

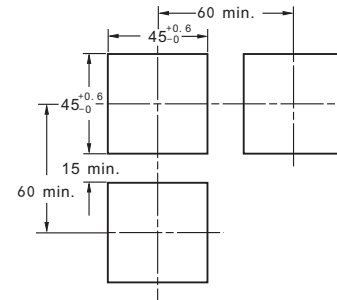

■ Key protection switch

Set the key protect level.
When the key-protect switch is set to ON, it is possible to prevent setting errors by prohibiting the use of certain operation keys by specifying the key protect level (KP-1 to KP-4). The key protect indicator is lit while the key-protect switch is set to ON. Confirm the ON/OFF status of the keyprotectswitch after the NC7CX is mounted to the panel.

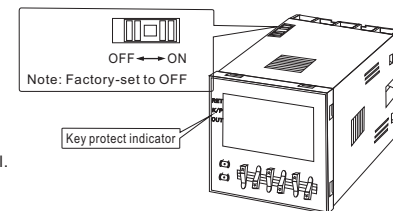

■ Settings for All Functions

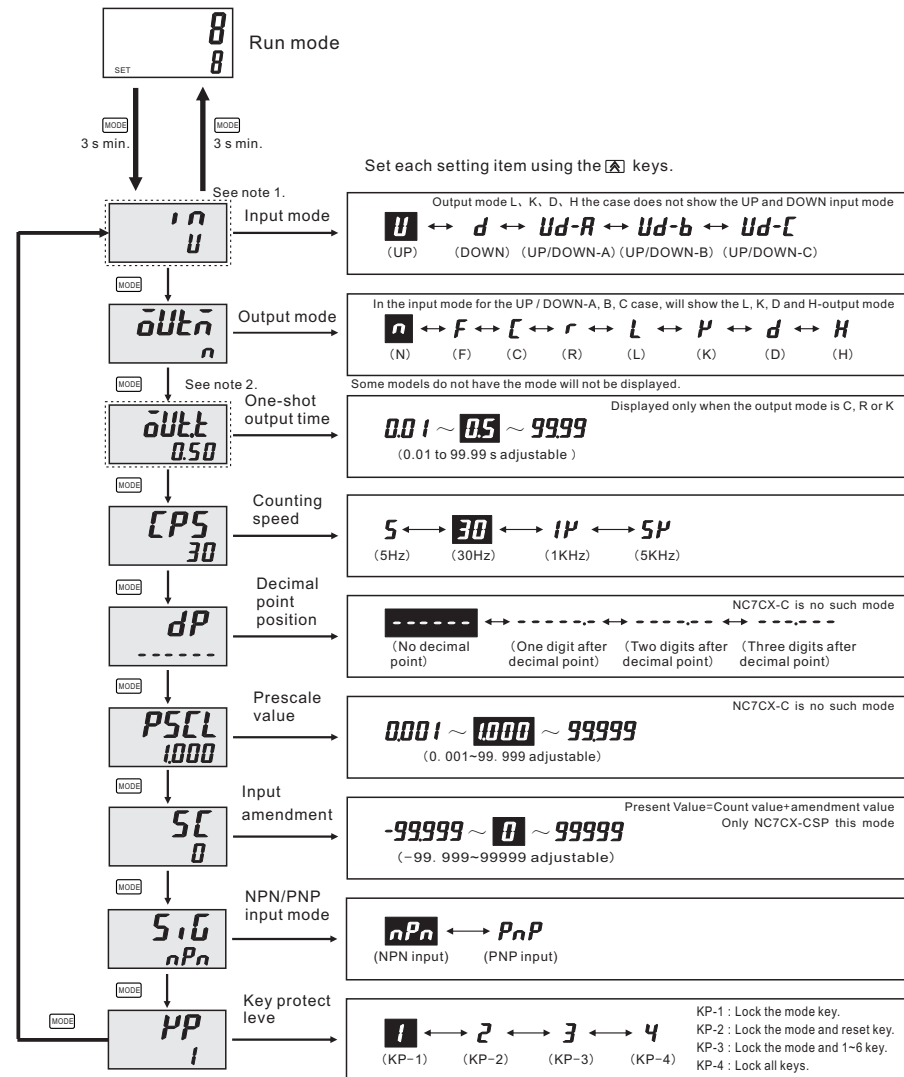

See note 1.

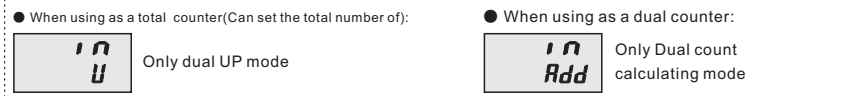

(3)

See note 2.

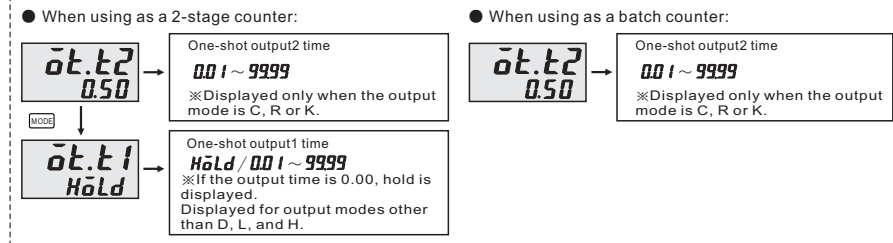

■ Operation in Run Mode

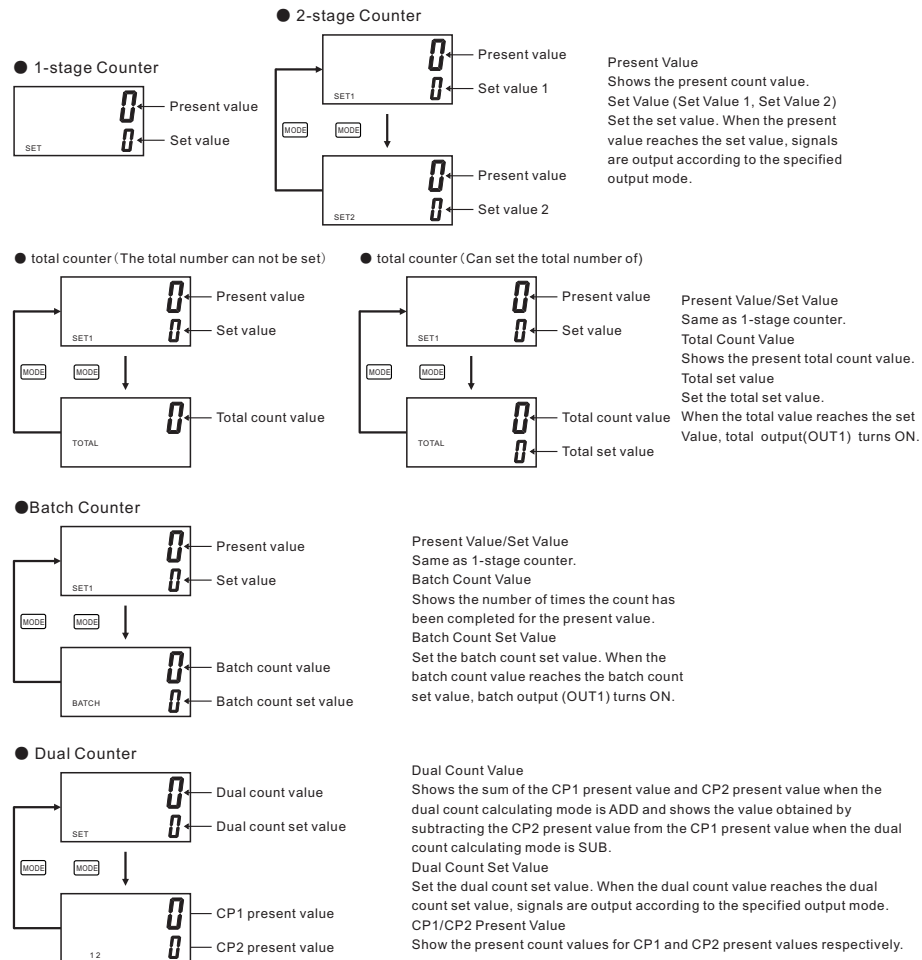

(4)

Input Modes and Present Value

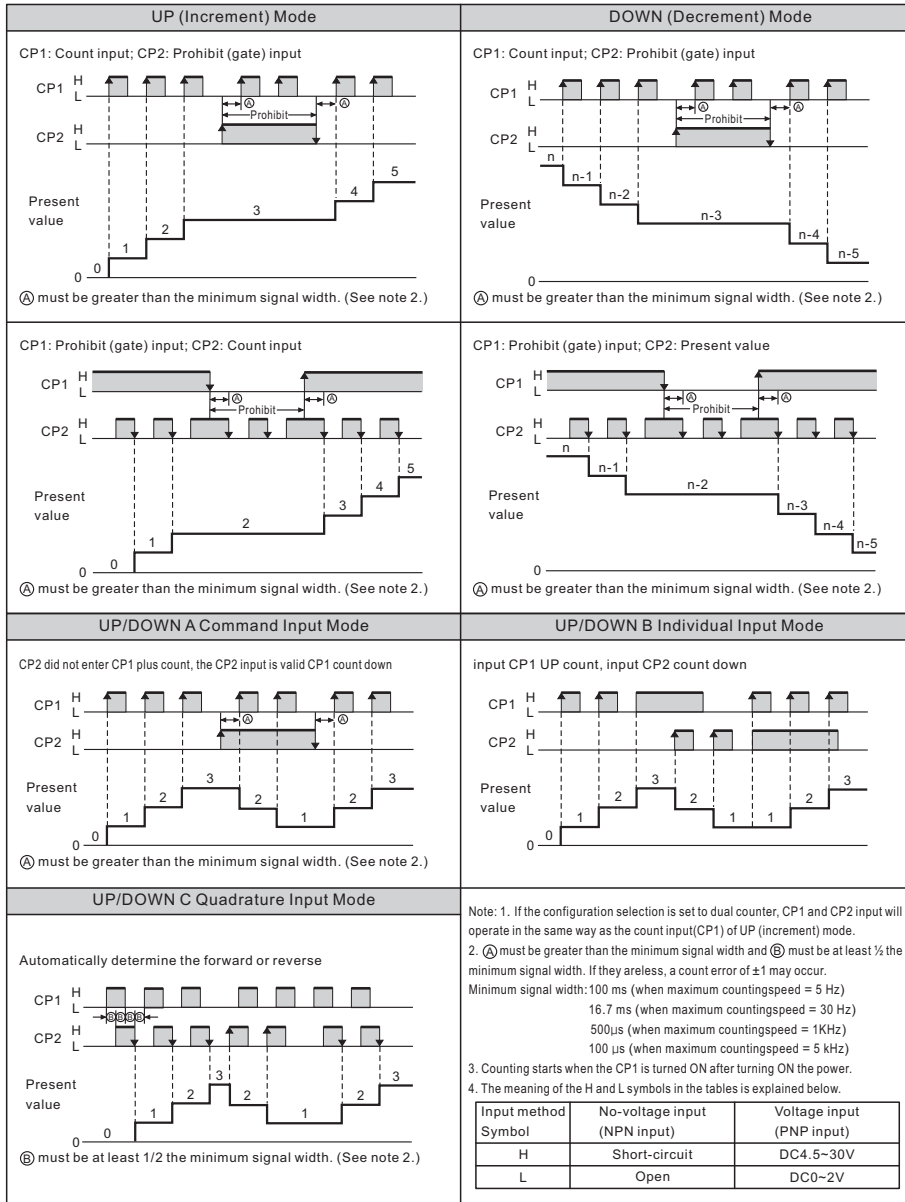

Input/Output Mode Settings

Operation for 1-stage models is the same as that for OUT2.

When using a 2-stage model as a 1-stage counter, total and preset counter, or dual counter, OUT1 and OUT2 turn ON and OFF simultaneously.

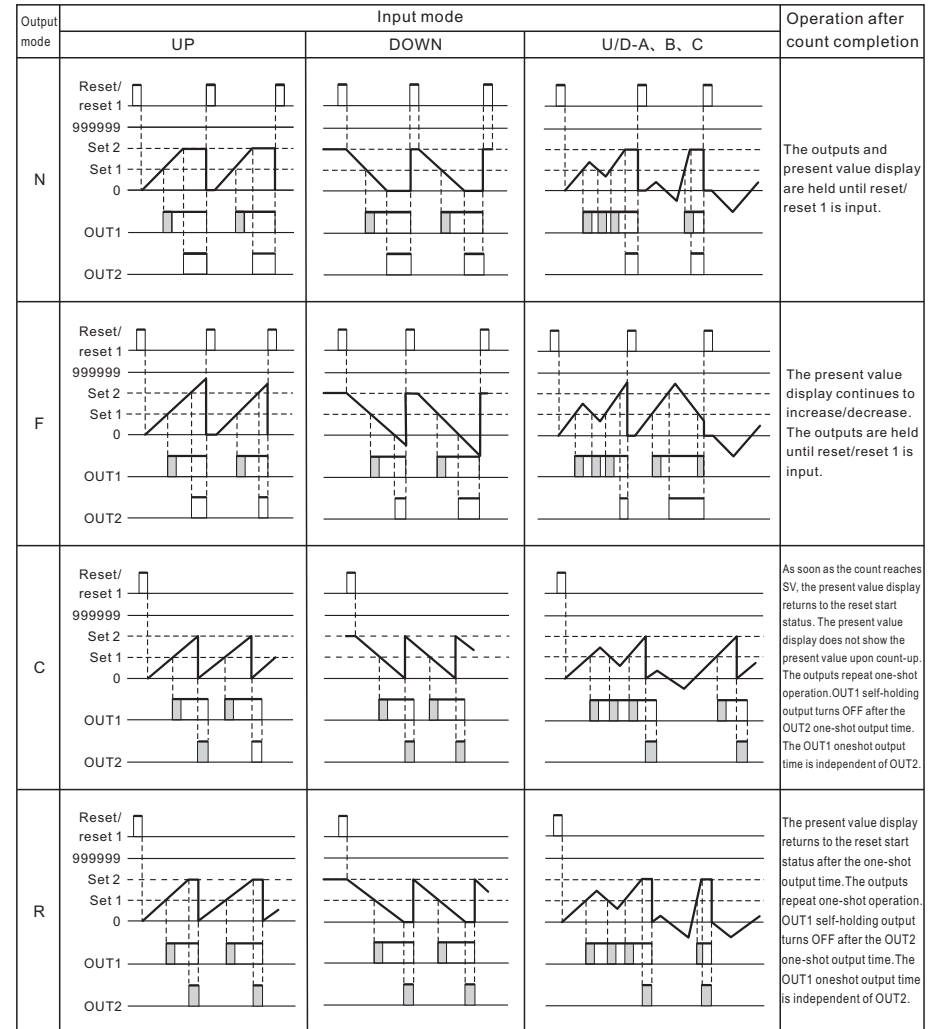
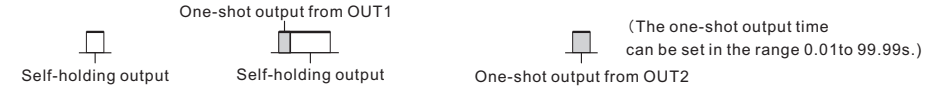

Self-holding output

Instantaneous(equals) output

One-shot output

(The one-shot output time can be set in the range 0.01 to 99.99s.)

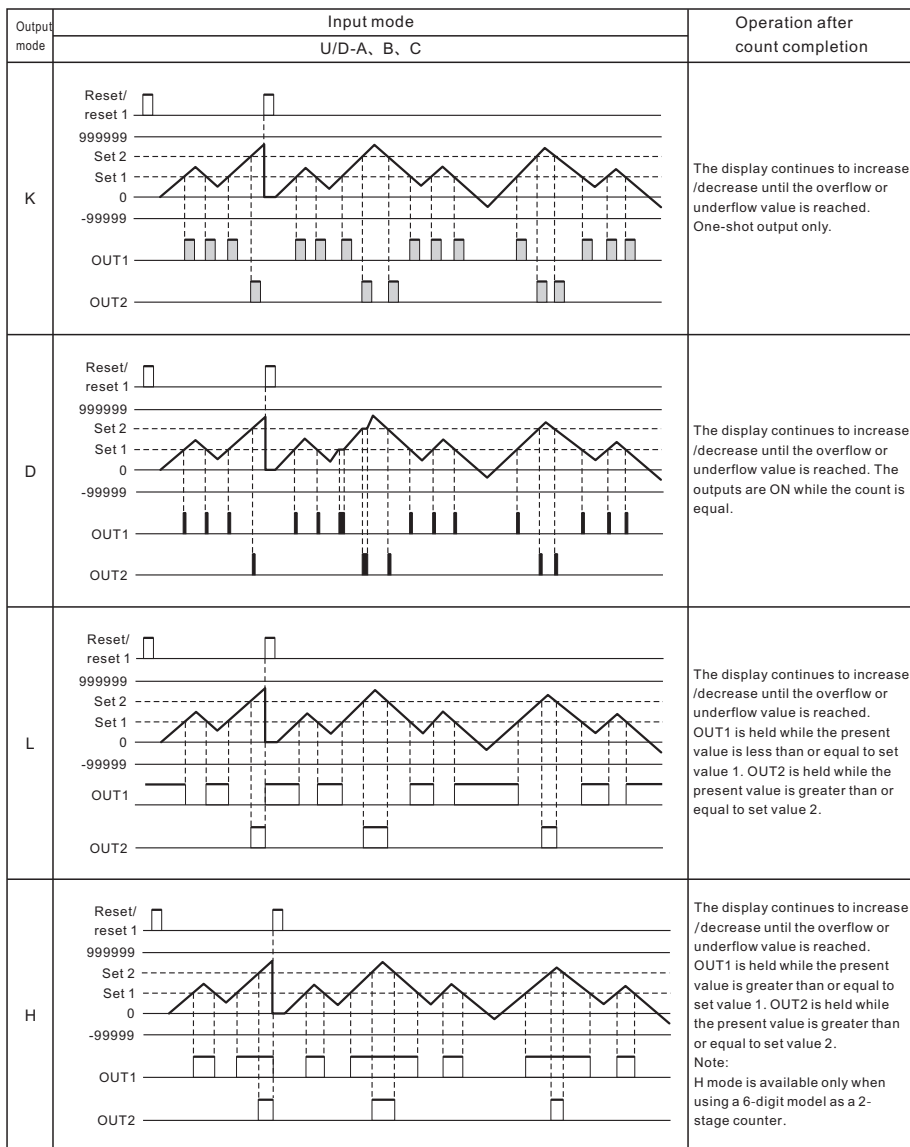

total counter、Batch Counter、Dual Counter Explain

- total counter (The total number can not be set) NC7CX-CAP

The NC7CX has a total counter, separate from the 1-stage preset counter, for counting the total accumulated value. Can replace a preset counter + 1 cumulative counter.

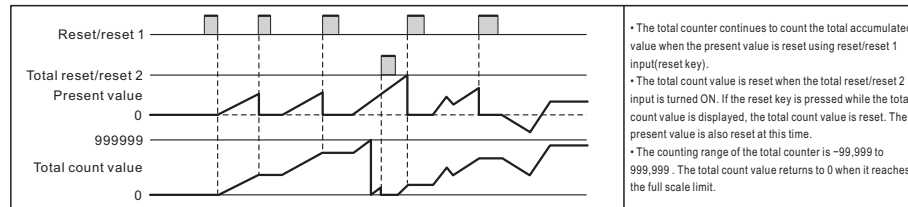

- total counter (Can set the total number of) NC7CX-CTP

Separate from a preset counter, plus the total preset counter.

Principle: each to the total amount of set value OUT1 is One-shot output (Output mode C), while the cumulative total no stop until it reaches Total Count Value OUT2 output. (Total output modes N, F, C, the R can be set). Can replace the two preset counter.

- The total counter continues to count the total accumulated value when the present value is reset using reset/reset 1 input(reset key).
- The total count value is reset when the total reset/reset 2 input is turned ON. If the reset key is pressed while the total count value is displayed, the total count value is reset. The present value is also reset at this time.

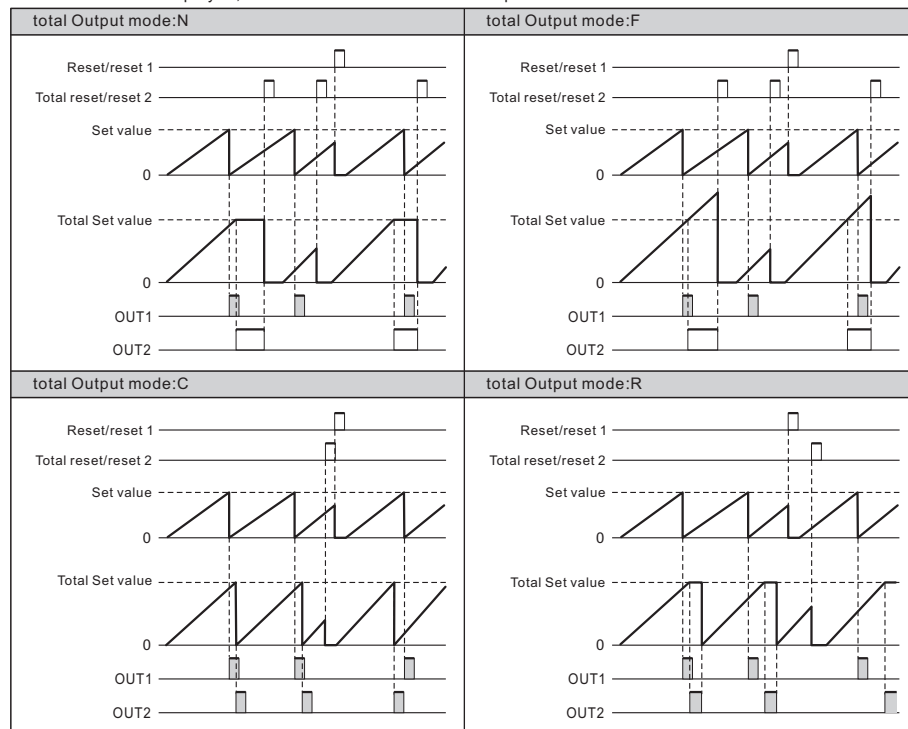

● Batch Counter NC7CX-CBP

The NC7CX has a batch counter, separate from the 1-stage preset counter, for counting the number of times the count has been completed.

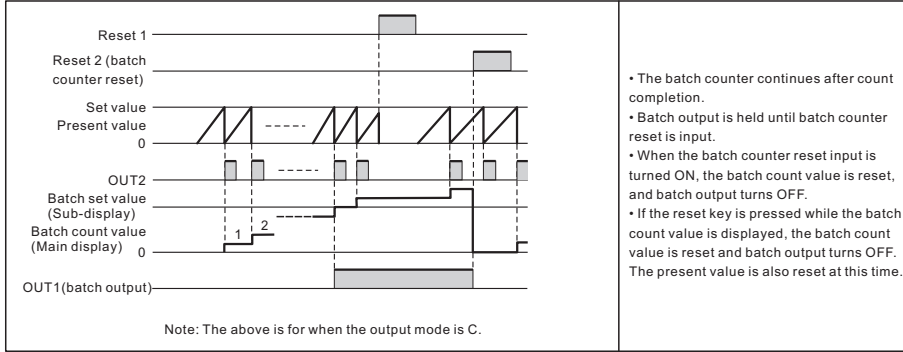

- The batch counter continues after count completion.
- Batch output is held until batch counter reset is input.
- When the batch counter reset input is turned ON, the batch count value is reset, and batch output turns OFF.
- If the reset key is pressed while the batch count value is displayed, the batch count value is reset and batch output turns OFF. The present value is also reset at this time.

● Dual Counter NC7CX-CDP

Using the dual counter allows the count from 2 inputs to be added or subtracted and the result displayed. It is possible to specify a set value for which output turns ON when the set value matches the added or subtracted result. OUT1 and OUT2 turn ON and OFF simultaneously.

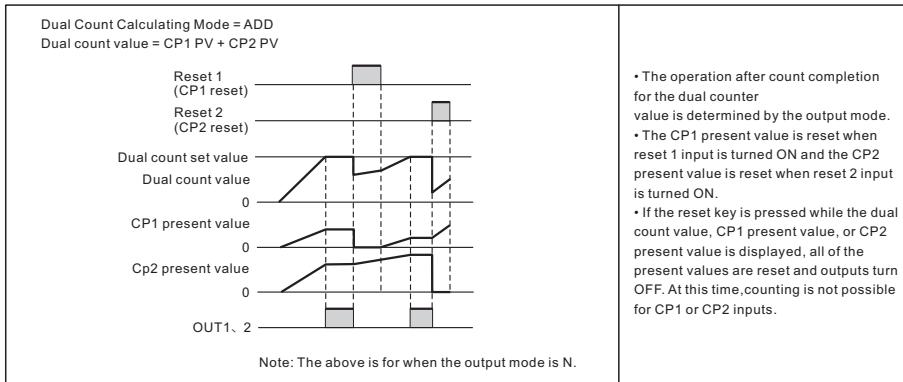

- The operation after count completion for the dual counter value is determined by the output mode.
- The CP1 present value is reset when reset 1 input is turned ON and the CP2 present value is reset when reset 2 input is turned ON.
- If the reset key is pressed while the dual count value, CP1 present value, or CP2 present value is displayed, all of the present values are reset and outputs turn OFF. At this time, counting is not possible for CP1 or CP2 inputs.

■ Reset Function List

Function	1-stage/2-stage counter	Total and preset counter		Batch counter		Dual counter	
		Present value/ set value	Total count value / Total Set value (NC7CX-CTP have)	Present value/ set value	Batch count value/ batch count set value	Dual count value/ dual count set value	CP1 present value/ CP2 present value
Screen displayed in run mode	Present value/ set value (1, 2)	Present value/ set value	Total count value / Total Set value (NC7CX-CTP have)	Present value/ set value	Batch count value/ batch count set value	Dual count value/ dual count set value	CP1 present value/ CP2 present value
Reset/reset 1	Present value and output reset.	Present value and set output reset.		Present value and output reset.		Only the CP1 present value is reset	
Total reset/reset 2	No effect.	Only the total count value is reset/total output.(NC7CX-CTP have)		Batch count value and batch output reset.		Only the CP2 present value is reset.	
Reset key	Present value and output reset.	Present value and output reset.	Present value, total count value, set output reset and total output reset .	Present value and output reset.	Present value, batch count value, output and batch output reset	Cp1 present value, CP2 present value, dual count value, and output reset.	

■ Wiring diagram

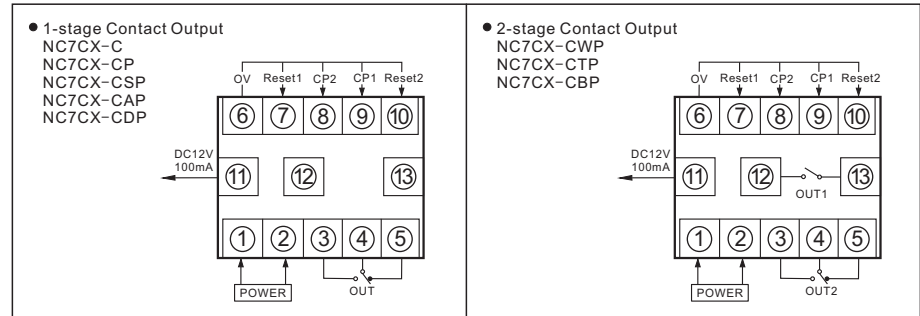

■ Signal input connection diagram

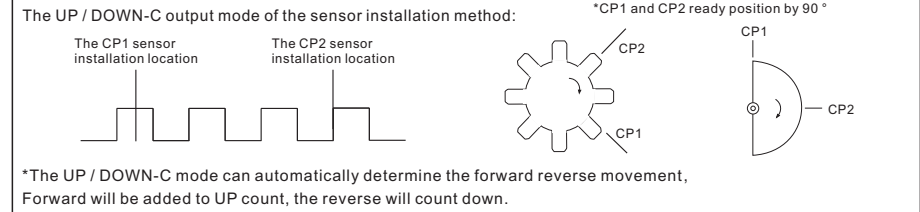
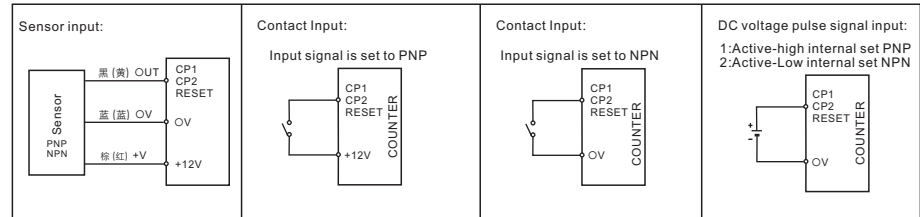

■ Note

- 1: before use, make sure that the voltage and connection, to avoid lead to instrument damage due to incorrect wiring.
- 2: Avoid the instrument used in high temperature, flammable, explosive, corrosive, dust, severe shock, humidity, static electricity, oil and other occasions.
- 3: Twist of the instrument signal lines and power lines may cause interference
Please try to stay away from these strong electric wires, to conduct an independent wiring, and signal lines as far as possible to shorten the wiring distance.
- 4: Contact signal input, the CPS count rate should be set for low-speed 30Hz, can Prevent switch bounce error count. Reasonable speed settings, you can make the count more accurate.
- 5: Output relay, please do not exceed the switching capacity, according to the rated load, otherwise it would contact burned, such as an external high current relay or contactor exceeds its capacity.