

Ø6.5

Ø6.5

Ø6.5

Ø6.5



2 mm

4 mm

2 mm

4 mm

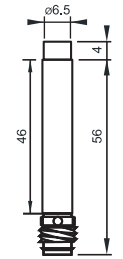
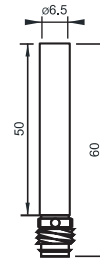
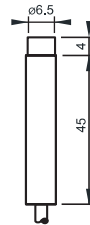

(Sn),

Ø 6.5	Ø 6.5	Ø 6.5	Ø 6.5
2 - 10...30 VDC, 3-	4 - 10...30 VDC, 3-	2 mm - 10...30 VDC, 3-pin	4 mm - 10...30 VDC, 3-pin
< 9 mA 200 mA	< 9 mA 200 mA	< 9 mA 200 mA	< 9 mA 200 mA
< 1.5 V @ 200 mA	< 1.5 V @ 200 mA	< 1.5 V @ 200 mA	< 1.5 V @ 200 mA
-	-	-	-
100 Hz	100 Hz	100 Hz	100 Hz
< 4 %	< 4 %	< 4 %	< 4 %
3...15 %	3...15 %	3...15 %	3...15 %
-25...+70 °C	-25...+70 °C	-25...+70 °C	-25...+70 °C
< 10 % (Sn)	< 10 % (Sn)	< 10 % (Sn)	< 10 % (Sn)
IP 67	IP 67	IP 67	IP 67
PVC, 2m	PVC, 2m	8, 3-pin	8, 3-pin

PNP, NO  
PNP, NC  
NPN, NO  
NPN, NC

CND6S2PO45A2P  
CND6S2PC45A2P  
CND6S2NO45A2P  
CND6S2NC45A2P

CND6N4PO45A2P  
CND6N4PC45A2P  
CND6N4NO45A2P  
CND6N4NC45A2P

CND6S2PO60M8  
CND6S2PC60M8  
CND6S2NO60M8  
CND6S2NC60M8

CND6N4PO60M8  
CND6N4PC60M8  
CND6N4NO60M8  
CND6N4NC60M8

Ø6.5      Ø6.5      M8      M8      M8      M8

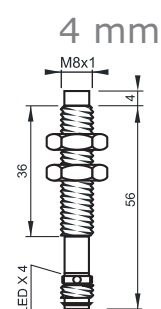
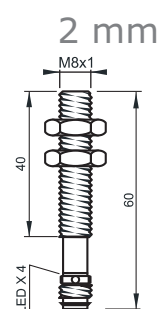
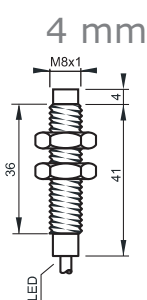
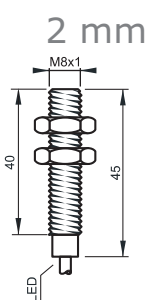
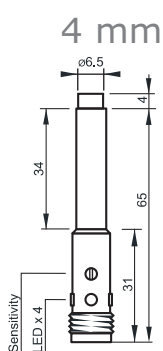
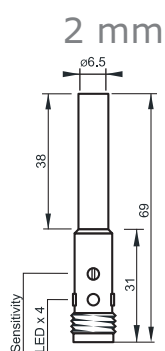

Ø 6.5	Ø 6.5	M8x1	M8x1	M8x1	M8x1
2 mm - , 10...30 VDC, 3-pin	4 mm - , 10...30 VDC, 3-pin	2 mm - , 10...30 VDC, 3-	4 mm - , 10...30 VDC, 3-	2 mm - , 10...30 VDC, 3-pin	4 mm - , 10...30 VDC, 3-pin
< 9 mA 200 mA	< 9 mA 200 mA	< 9 mA 200 mA	< 9 mA 200 mA	< 9 mA 200 mA	< 9 mA 200 mA
< 1.5 V @ 200 mA 2	< 1.5 V @ 200 mA 2	< 1.5 V @ 200 mA -	< 1.5 V @ 200 mA -	< 1.5 V @ 200 mA -	< 1.5 V @ 200 mA -
100 Hz < 4 % 3...15 % -25...+70 °C < 10 % (Sn) IP 67	100 Hz < 4 % 3...15 % -25...+70 °C < 10 % (Sn) IP 67	100 Hz < 4 % 3...15 % -25...+70 °C < 10 % (Sn) IP 67	100 Hz < 4 % 3...15 % -25...+70 °C < 10 % (Sn) IP 67	100 Hz < 4 % 3...15 % -25...+70 °C < 10 % (Sn) IP 67	100 Hz < 4 % 3...15 % -25...+70 °C < 10 % (Sn) IP 67
M12, 4-pin	M12, 4-pin	PVC, 2m	PVC, 2m	M8, 3-pin	M8, 3-pin

CND6S2PO70M12	CND6N4PO70M12	CN8S2PO45A2P	CN8N4PO45A2P	CN8S2PO60M8	CN8N4PO60M8
CND6S2PC70M12	CND6N4PC70M12	CN8S2PC45A2P	CN8N4PC45A2P	CN8S2PC60M8	CN8N4PC60M8
CND6S2NO70M12	CND6N4NO70M12	CN8S2NO45A2P	CN8N4NO45A2P	CN8S2NO60M8	CN8N4NO60M8
CND6S2NC70M12	CND6N4NC70M12	CN8S2NC45A2P	CN8N4NC45A2P	CN8S2NC60M8	CN8N4NC60M8

M12, 4-pin

M12, 4-pin

-

-

M8, 3-pin

M8, 3-pin

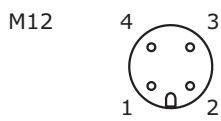
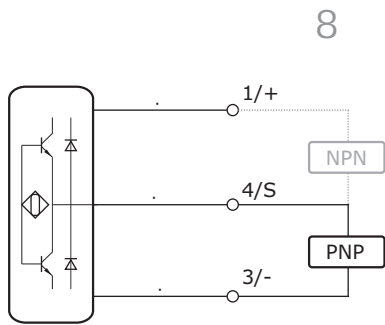

M8 M8 M12 M12



2 mm

4 mm

4 mm

6 mm

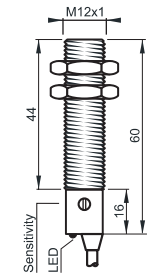
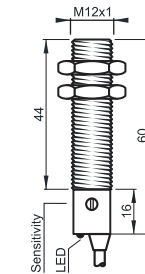
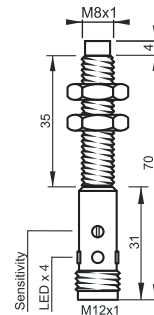
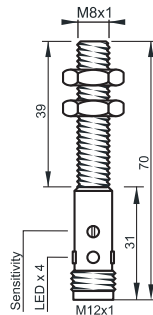

		M8x1	M8x1	M12x1	M12x1
	(Sn),	2 mm - ,	4 mm - ,	4 mm - ,	6 mm - ,
		10...30 VDC, 3-pin	10...30 VDC, 3-pin	10...30 VDC, 3-	10...30 VDC, 3-
C		< 9 mA	< 9 mA	< 9 mA	< 9 mA
	2	200 mA	200 mA	200 mA	200 mA
C		< 1.5 V @ 200 mA	< 1.5 V @ 200 mA	< 1.5 V @ 200 mA	< 1.5 V @ 200 mA
	2				
	8	100 Hz	100 Hz	100 Hz	100 Hz
		< 4 %	< 4 %	< 4 %	< 4 %
		3...15 %	3...15 %	3...15 %	3...15 %
8		-25...+70 °C	-25...+70 °C	-25...+70 °C	-25...+70 °C
		< 10 % (Sn)	< 10 % (Sn)	< 10 % (Sn)	< 10 % (Sn)
C		IP 67	IP 67	IP 67	IP 67
		M12, 4-pin	M12, 4-pin	PVC, 2m	PVC, 2m
	8				
PNP, NO		CN8S2PO70M12	CN8N4PO70M12	CN12S4PO60A2P	CN12S6PO60A2P
PNP, NC		CN8S2PC70M12	CN8N4PC70M12	CN12S4PC60A2P	CN12S6PC60A2P
NPN, NO		CN8S2NO70M12	CN8N4NO70M12	CN12S4NO60A2P	CN12S6NO60A2P
NPN, NC		CN8S2NC70M12	CN8N4NC70M12	CN12S4NC60A2P	CN12S6NC60A2P

M12 M12 M12 M12 M12 M12

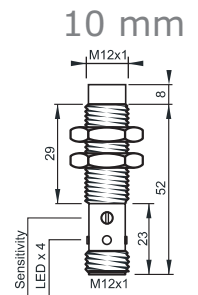
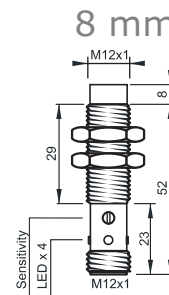
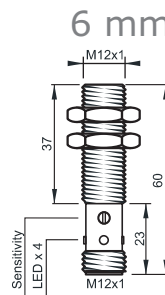
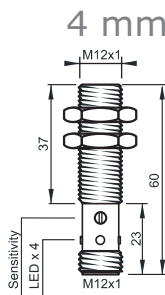
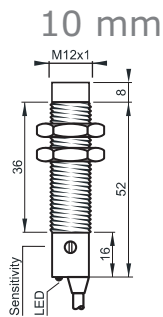
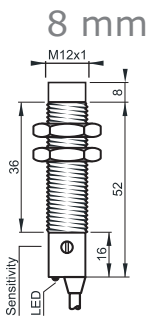

M12x1	M12x1	M12x1	M12x1	M12x1	M12x1
8 mm - , 10...30 VDC, 3-	10 mm - , 10...30 VDC, 3-	4 mm - , 10...30 VDC, 3-pin	6 mm - , 10...30 VDC, 3-pin	8 mm - , 10...30 VDC, 3-pin	10 mm - , 10...30 VDC, 3-pin
< 9 mA 200 mA	< 9 mA 200 mA	< 9 mA 200 mA	< 9 mA 200 mA	< 9 mA 200 mA	< 9 mA 200 mA
< 1.5 V @ 200 mA 2	< 1.5 V @ 200 mA 2	< 1.5 V @ 200 mA 2	< 1.5 V @ 200 mA 2	< 1.5 V @ 200 mA 2	< 1.5 V @ 200 mA 2
100 Hz < 4 % 3...15 % -25...+70 °C < 10 % (Sn) IP 67	100 Hz < 4 % 3...15 % -25...+70 °C < 10 % (Sn) IP 67	100 Hz < 4 % 3...15 % -25...+70 °C < 10 % (Sn) IP 67	100 Hz < 4 % 3...15 % -25...+70 °C < 10 % (Sn) IP 67	100 Hz < 4 % 3...15 % -25...+70 °C < 10 % (Sn) IP 67	100 Hz < 4 % 3...15 % -25...+70 °C < 10 % (Sn) IP 67
PVC, 2m	PVC, 2m	M12, 4-pin	M12, 4-pin	M12, 4-pin	M12, 4-pin

CN12N8PO60A2P	CN12N10PO60A2P	CN12S4PO60M12	CN12S6PO60M12	CN12N8PO60M12	CN12N10PO60M12
CN12N8PC60A2P	CN12N10PC60A2P	CN12S4PC60M12	CN12S6PC60M12	CN12N8PC60M12	CN12N10PC60M12
CN12N8NO60A2P	CN12N10NO60A2P	CN12S4NO60M12	CN12S6NO60M12	CN12N8NO60M12	CN12N10NO60M12
CN12N8NC60A2P	CN12N10NC60A2P	CN12S4NC60M12	CN12S6NC60M12	CN12N8NC60M12	CN12N10NC60M12

- M12, 4-pin M12, 4-pin M12, 4-pin M12, 4-pin

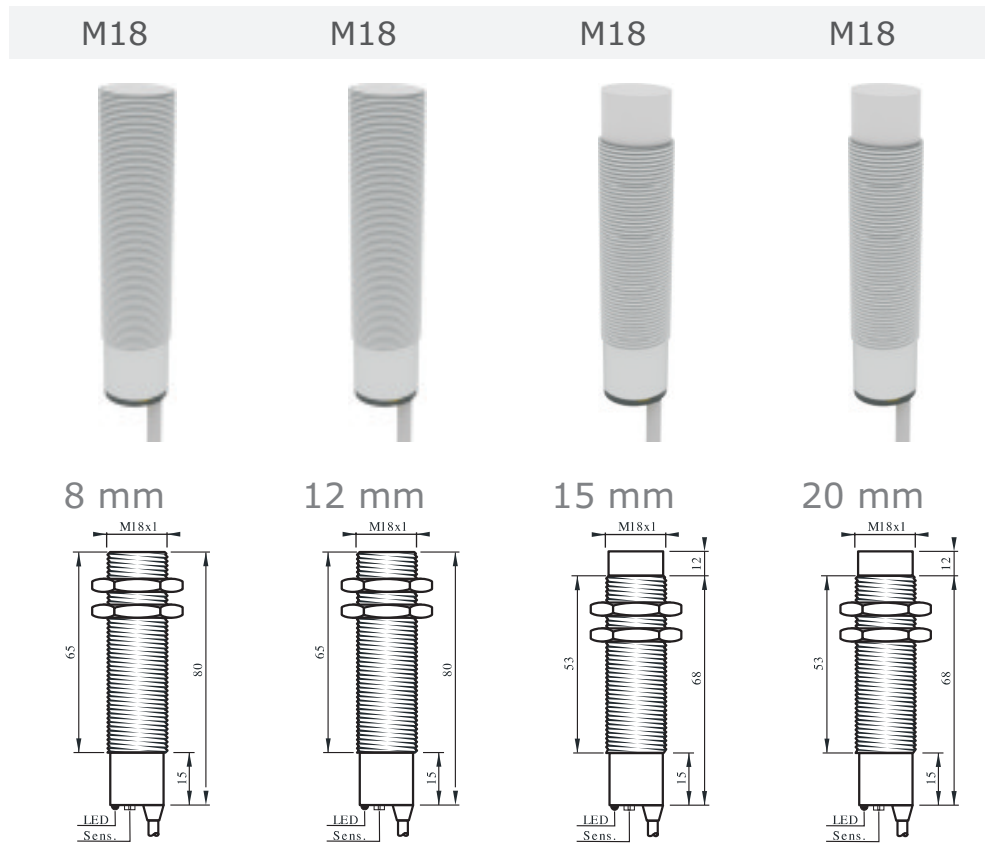
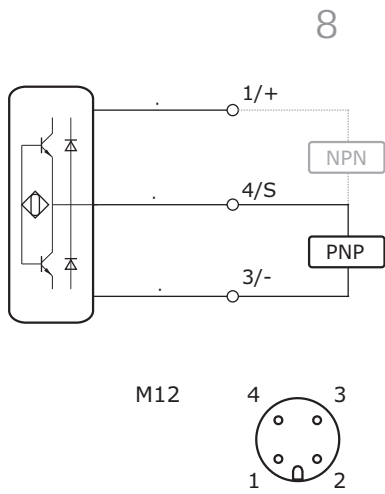

			M18x1	M18x1	M18x1	M18x1
		(Sn),	8 mm - ,	12 mm - ,	15 mm - ,	20 mm - ,
			10...30 VDC, 3-	10...30 VDC, 3-	10...30 VDC, 3-	10...30 VDC, 3-
C			< 9 mA	< 9 mA	< 9 mA	< 9 mA
			200 mA	200 mA	200 mA	200 mA
C	2		< 1.5 V @ 200 mA	< 1.5 V @ 200 mA	< 1.5 V @ 200 mA	< 1.5 V @ 200 mA
			2	2	2	2
	8		100 Hz	100 Hz	100 Hz	100 Hz
			< 4 %	< 4 %	< 4 %	< 4 %
			3...15 %	3...15 %	3...15 %	3...15 %
8			-25...+70 °C	-25...+70 °C	-25...+70 °C	-25...+70 °C
			< 10 % (Sn)	< 10 % (Sn)	< 10 % (Sn)	< 10 % (Sn)
	C		IP 67	IP 67	IP 67	IP 67
			PVC, 2m	PVC, 2m	PVC, 2m	PVC, 2m
	8					
PNP, NO			CN18S8PO80A2P	CN18S12PO80A2P	CN18N15PO80A2P	CN18N20PO80A2P
PNP, NC			CN18S8PC80A2P	CN18S12PC80A2P	CN18N15PC80A2P	CN18N20PC80A2P
NPN, NO			CN18S8NO80A2P	CN18S12NO80A2P	CN18N15NO80A2P	CN18N20NO80A2P
NPN, NC			CN18S8NC80A2P	CN18S12NC80A2P	CN18N15NC80A2P	CN18N20NC80A2P
2- +		NO, 20...250 VAC	.	-	.	-
2- +		NC, 20...250 VAC	.	-	.	-

M18 M18 M18 M18 M30 M30

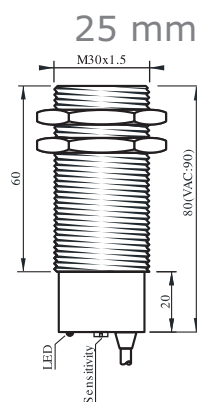
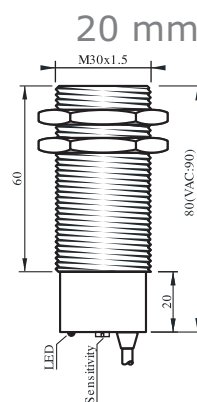
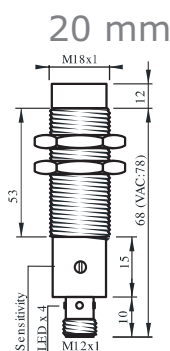
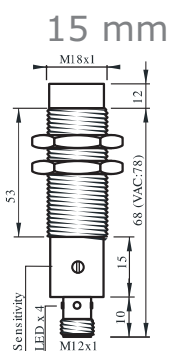
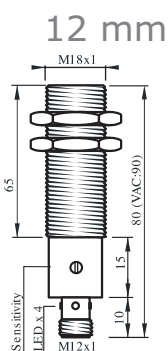
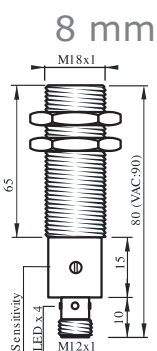

M18x1	M18x1	M18x1	M18x1	M30x1.5	M30x1.5
8 mm - , 10...30 VDC, 3-pin	12 mm - , 10...30 VDC, 3-pin	15 mm - , 10...30 VDC, 3-pin	20 mm - , 10...30 VDC, 3-pin	20 mm - , 10...30 VDC, 3-	25 mm - , 10...30 VDC, 3-
< 9 mA 200 mA	< 9 mA 200 mA	< 9 mA 200 mA	< 9 mA 200 mA	< 9 mA 200 mA	< 9 mA 200 mA
< 1.5 V @ 200 mA 2	< 1.5 V @ 200 mA 2	< 1.5 V @ 200 mA 2	< 1.5 V @ 200 mA 2	< 1.5 V @ 200 mA 2	< 1.5 V @ 200 mA 2
100 Hz < 4 % 3...15 % -25...+70 °C < 10 % (Sn) IP 67	100 Hz < 4 % 3...15 % -25...+70 °C < 10 % (Sn) IP 67	100 Hz < 4 % 3...15 % -25...+70 °C < 10 % (Sn) IP 67	100 Hz < 4 % 3...15 % -25...+70 °C < 10 % (Sn) IP 67	100 Hz < 4 % 3...15 % -25...+70 °C < 10 % (Sn) IP 67	100 Hz < 4 % 3...15 % -25...+70 °C < 10 % (Sn) IP 67
M12, 4-pin	M12, 4-pin	M12, 4-pin	M12, 4-pin	PVC, 2m	PVC, 2m
CN18S8PO80M12 CN18S8PO80M12 CN18S8NO80M12 CN18S8NC80M12	CN18S12PO80M12 CN18S12PO80M12 CN18S12NO80M12 CN18S12NC80M12	CN18N15PO80M12 CN18N15PO80M12 CN18N15NO80M12 CN18N15NC80M12	CN18N20PO80M12 CN18N20PO80M12 CN18N20NO80M12 CN18N20NC80M12	CN30S20PO80A2P CN30S20PC80A2P CN30S20NO80A2P CN30S20NC80A2P	CN30S25PO80A2P CN30S25PC80A2P CN30S25NO80A2P CN30S25NC80A2P
M12, 4-pin	M12, 4-pin	M12, 4-pin	M12, 4-pin	-	-

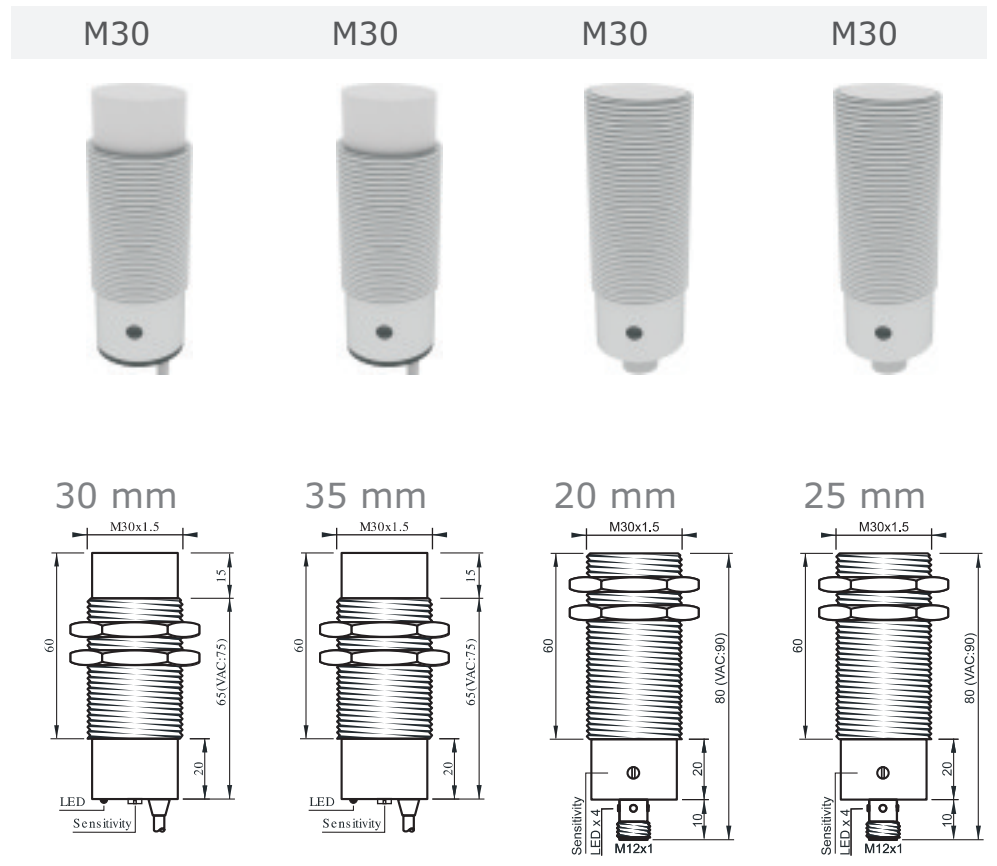
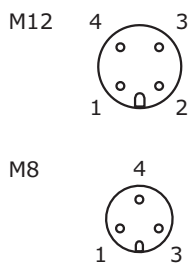
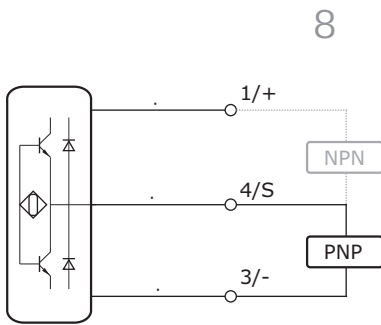

			M30x1.5	M30x1.5	M30x1.5	M30x1.5
(Sn),			30 mm - ,	35 mm - ,	20 mm - ,	25 mm - ,
C			10...30 VDC, 3-	10...30 VDC, 3-	10...30 VDC, 3-pin	10...30 VDC, 3-pin
C	2		< 9 mA	< 9 mA	< 9 mA	< 9 mA
			200 mA	200 mA	200 mA	200 mA
			< 1.5 V @ 200 mA	< 1.5 V @ 200 mA	< 1.5 V @ 200 mA	< 1.5 V @ 200 mA
	8		2	2	2	2
			100 / 25 Hz	100 Hz	100 / 25 Hz	100 Hz
			< 4 %	< 4 %	< 4 %	< 4 %
			3...15 %	3...15 %	3...15 %	3...15 %
8			-25...+70 °C	-25...+70 °C	-25...+70 °C	-25...+70 °C
			< 10 % (Sn)	< 10 % (Sn)	< 10 % (Sn)	< 10 % (Sn)
C			IP 67	IP 67	IP 67	IP 67
			PVC, 2m	PVC, 2m	M12, 4-pin	M12, 4-pin
8						
PNP, NO			CN30N30PO80A2P	CN30N35PO80A2P	CN30S20PO80M12	CN30S25PO80M12
PNP, NC			CN30N30PC80A2P	CN30N35PC80A2P	CN30S20PC80M12	CN30S25PC80M12
NPN, NO			CN30N30NO80A2P	CN30N35NO80A2P	CN30S20NO80M12	CN30S25NO80M12
NPN, NC			CN30N30NC80A2P	CN30N35NC80A2P	CN30S20NC80M12	CN30S25NC80M12
2- +		NO, 20...250 VAC	.	.	.	.
2- +		NC, 20...250 VAC	.	.	.	.
					M12, 4-pin	M12, 4-pin

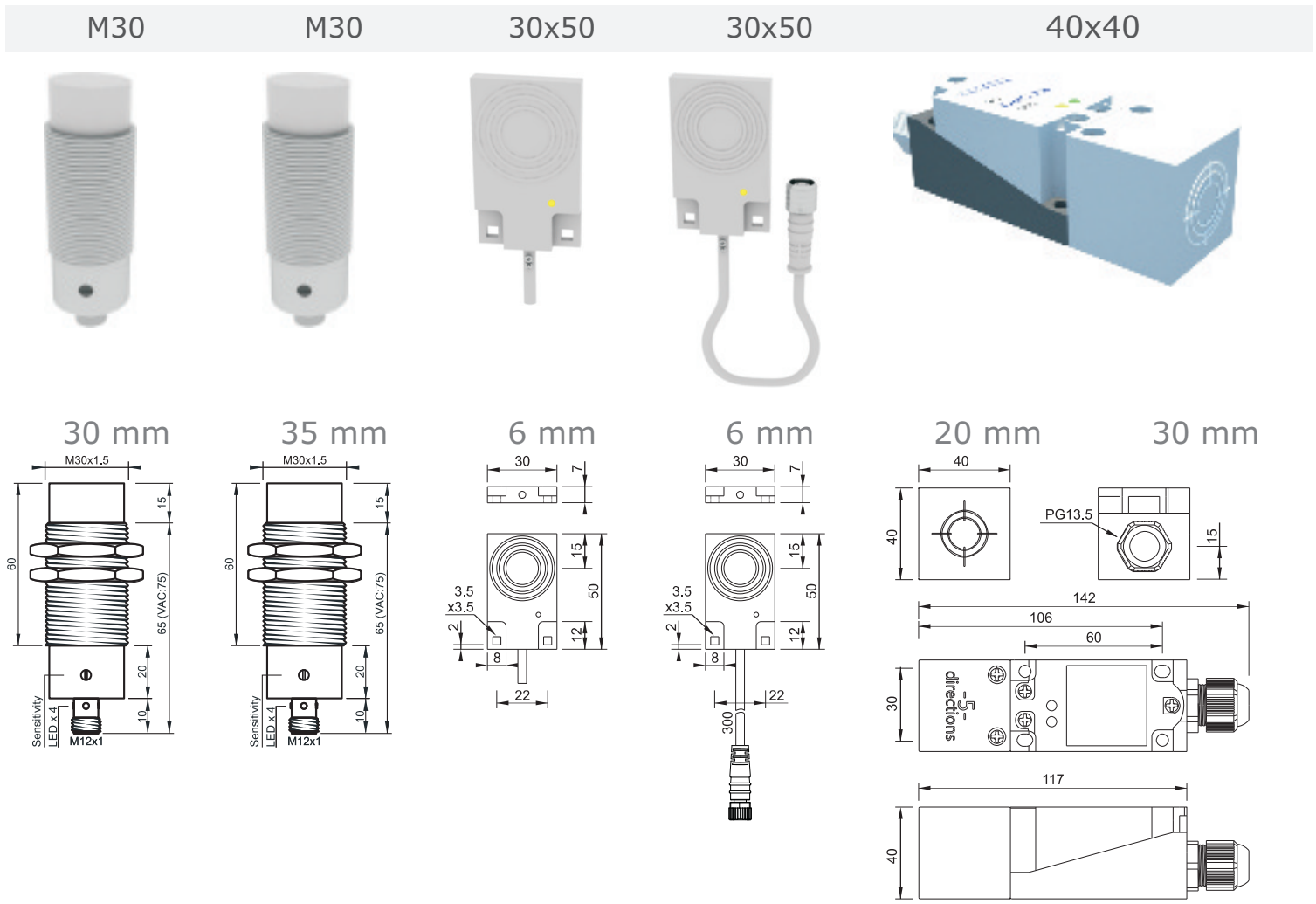

M30x1.5	M30x1.5	30x50	30x50	40x40 mm	40x40 mm
30 mm - , 10...30 VDC, 3-pin built-in	35 mm - , 10...30 VDC, 3-pin	6 mm - , 10...30 VDC, 3-	6 mm - , 10...30 VDC, 3-pin	20 mm - , 10...30 VDC, 3-	30 mm - , 10...30 VDC, 3-
< 9 mA 200 mA	< 9 mA 200 mA	< 9 mA 200 mA	< 9 mA 200 mA	< 10 mA 200 mA	< 10 mA 200 mA
< 1.5 V @ 200 mA 2	< 1.5 V @ 200 mA 2	< 1.5 V @ 200 mA 2	< 1.5 V @ 200 mA 2	< 1.5 V @ 200 mA 2	< 1.5 V @ 200 mA 2
100 / 25 Hz < 4 % 3...15 % -25...+70 °C < 10 % (Sn) IP 67	100 Hz < 4 % 3...15 % -25...+70 °C < 10 % (Sn) IP 67	100 Hz < 4 % 3...15 % -25...+70 °C < 10 % (Sn) IP 67	100 Hz < 4 % 3...15 % -25...+70 °C < 10 % (Sn) IP 67	100 / 25 Hz < 5 % 3...15 % -25...+70 °C < 10 % (Sn) IP 67	100 Hz < 5 % 3...15 % -25...+70 °C < 10 % (Sn) IP 67
M12, 4-pin	M12, 4-pin	PBT PVC, 2m	PBT M8,3-pin,300	PBT PG13.5,	PBT PG13.5,

CN30N30PO80M12	CN30N35PO80M12	CN30S05S6PO7A2P	CN30S05S6PO73P8	CN40S20POLPG13	CN40N30POLPG13
CN30N30PC80M12	CN30N35PC80M12	CN30S05S6PC7A2P	CN30S05S6PC73P8	CN40S20PCLPG13	CN40N30PCLPG13
CN30N30NO80M12	CN30N35NO80M12	CN30S05S6NO7A2P	CN30S05S6NO73P8	CN40S20NOLPG13	CN40N30NOLPG13
CN30N30NC80M12	CN30N35NC80M12	CN30S05S6NC7A2P	CN30S05S6NC73P8	CN40S20NCLPG13	CN40N30NCLPG13
-	-	-	-	-	-
M12, 4-pin	M12, 4-pin	-	M8, 3-pin	-	-